

PR
electronics



5 3 3 4

**2-проводный
программируемый
преобразователь**

№. 5334V108-RU

От серийного №
141365001



ATEX



Revision Notes

The following list provides notes concerning revisions of this document.

Rev. ID	Date	Notes
108	13/45	IECEX and INMETRO approvals added

2-ПРОВОДНЫЙ ПРОГРАММИРУЕМЫЙ ПРЕОБРАЗОВАТЕЛЬ

PRetop 5334

Содержание

Области применения.....	2
Техническая характеристика.....	2
Монтаж / установка.....	2
Схемы применений.....	3
Расшифровка кода заказа: 5334.....	4
Электрические данные.....	4
Схемы присоединения.....	7
Принципиальная схема.....	8
Программирование.....	9
Установочные размеры.....	10
Монтаж кабеля датчика.....	10
Приложение.....	11
ATEX Installation Drawing - 5334A.....	12
ATEX Installation Drawing - 5334B.....	13
IECEx Installation Drawing - 5334A.....	15
IECEx Installation Drawing - 5334B.....	16
INMETRO Instruções de Segurança - 5334A.....	18
INMETRO Instruções de Segurança - 5334B.....	19

2-ПРОВОДНЫЙ ПРОГРАММИРУЕМЫЙ ИЗМЕРИТЕЛЬНЫЙ ПРЕОБРАЗОВАТЕЛЬ PRetop 5334

- *Вход термопары*
- *Высокая точность измерения*
- *Гальваническая развязка*
- *Программируемое значение погрешности датчика*
- *Возможность монтажа в головку датчика по ст. DIN форма В*

Области применения

- Линеаризация температуры, измеренной термочувствительным элементом.
- Усиление биполярного mV-сигнала, в т.ч. линеаризованного или определенного функцией линеаризации до стандартного токового сигнала 4...20 mA.

Техническая характеристика

- В течение нескольких секунд пользователь может запрограммировать PR5334 на измерение температуры в пределах откалиброванных для термопар диапазонов.
- Компенсация холодного спая С/С с встроенным датчиком температуры.
- Архивированные данные регулярно подвергаются контролю на сохранность.

Монтаж / установка

- Может монтироваться в корпус датчика по ст. DIN форма В или на рейку DIN при помощи специального крепления.
- **ВНИМАНИЕ:** В качестве Ех-барьеров к 5334В мы рекомендуем 5104В, 5114В или 5116В.

СХЕМЫ ПРИМЕНЕНИЙ

Термопара к 4...20 mA

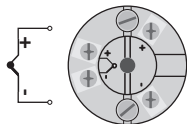

2-проводная установка
на контрольном пункте

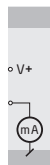

mV к 4...20 mA

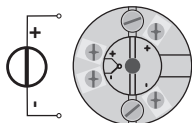

2-проводная установка
на контрольном пункте

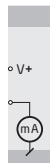

**Расшифровка кода
заказа: 5334**

Тип	Исполнение	Рабочая температура среды	Гальваническая изоляция
5334	Стандарт : A ATEX Ex, IECEx & INMETRO : B	-40°C...+85°C : 3	1500 VAC : B

Электрические данные

Диапазон рабочих температур среды:

От -40°C до +85°C

Общие данные:

Напряжение питания, DC

Стандартное исполнение..... 7,2...35 V

ATEX Ex, IECEx & INMETRO 7,2...30 VDC

Потребляемая мощность..... 25 mW...0,8 W

Падение напряжения..... 7,2 VDC

Изоляция, напряжение тестовое/рабочее 1,5 kVAC / 50 VAC

Время разогрева..... 5 мин.

Интерфейс обмена данными..... Loop Link

Отношение сигнал/шум..... Мин. 60 dB

Время реакции (программируемое)..... 1...60 сек.

Контроль данных в EEPROM < 3,5 сек.

Динамический диапазон сигнала, вход..... 18 bit

Динамический диапазон сигнала, выход. 16 bit

Температура калибровки 20...28°C

Точность, большее из общих и базовых значений:

Общие значения		
Тип входа	Абс. погрешность	Зависимость от температуры
Все	≤ ±0,05% от диап.	≤ ±0,01% от диап. / °C

Базовые значения		
Тип входа	Основная погрешность	Зависимость от температуры
Напряжение	$\leq \pm 10 \mu V$	$\leq \pm 1 \mu V / ^\circ C$
Типы термопар: E, J, K, L, N, T, U	$\leq \pm 1^\circ C$	$\leq \pm 0,05^\circ C / ^\circ C$
Типы термопар: B, R, S, W3, W5, LR	$\leq \pm 2^\circ C$	$\leq \pm 0,2^\circ C / ^\circ C$

Зависимость помехоустойчивости по ЭМС..... $< \pm 0,5\%$ от диап.
Улучшенная помехоустойчивость по ЭМС:
NAMUR NE 21, исп. импульсным напр. уровня А $< \pm 1\%$ от диап.

Реакция на изменение напряжения-

питания..... $< 0,005\%$ от диап./VDC
Устойчивость к вибрации IEC 60068-2-6 Тест FC
Спецификация по Lloyd № 1 4 g / 2...100 Hz
Макс. сечение проводника..... 1 x 1,5 мм² многожильный
Отн. влажность воздуха $< 95\%$ (без конденсата)
Момент затяжки винта клеммы 0,4 Nm
Размеры $\varnothing 44 \times 20,2$ мм
Класс защиты (корпус/клемма) IP68 / IP00
Вес 50 г

Электрические данные, вход:

Макс. смещение нуля (коррекция)..... 50% выбранного макс. значения

Вход термопар:

Тип	Мин. темп.	Макс. темп.	Мин. диап.	Стандарт
B	+400°C	+1820°C	100°C	IEC584
E	-100°C	+1000°C	50°C	IEC584
J	-100°C	+1200°C	50°C	IEC584
K	-180°C	+1372°C	50°C	IEC584
L	-100°C	+900°C	50°C	DIN 43710
N	-180°C	+1300°C	50°C	IEC584
R	-50°C	+1760°C	100°C	IEC584
S	-50°C	+1760°C	100°C	IEC584
T	-200°C	+400°C	50°C	IEC584
U	-200°C	+600°C	50°C	DIN 43710
W3	0°C	+2300°C	100°C	ASTM E988-90
W5	0°C	+2300°C	100°C	ASTM E988-90
LR	-200°C	+800°C	50°C	GOST 3044-84

Компенсация холодного спая (С/С)	< ±1,0°С
Обнаружение сбоя датчика	Да
Ток обнаружения сбоя датчика:	
в процессе обнаружения	номинальный 33 мА
иначе	0 мА

Вход напряжения:

Диапазон измерения.....	-12...150 mV
Мин. диапазон измерения (шкала)	5 mV
Входное сопротивление.....	10 MΩ

Выход:

Токовый выход:

Диапазон сигнала	4...20 mA
Мин. диапазон сигнала.....	16 mA
Время актуализации.....	440 миллисек.
Выходной сигнал при сбое EEPROM	≤ 3,5 mA
Сопротивление нагрузки.....	≤ (Vпитания - 7,2) / 0,023 [Ω]
Стабильность нагрузки.....	< ±0,01% от диап./ 100 Ω

Обнаружение сбоя датчика:

Программируемое	3,5...23 mA
NAMUR NE43 вверх	23 mA
NAMUR NE43 вниз.....	3,5 mA

От диап. = от актуально выбранного диапазона

Сертификаты:

EMC 2004/108/EC	EN 61326-1
ГОСТ Р	

Одобрение для применения на судах и платформах:

Det Norske Veritas, Правила для судов Стандарт сертиф. №. 2.4

Сертификация по Ex / I.S.:

ATEX 94/9/EC	
5334A.....	KEMA 10ATEX0002 X
5334B.....	KEMA 06ATEX0062 X
IECEx	DEK 13.0035X
INMETRO	DEKRA 13.0001 X
ГОСТ Ex	

СХЕМЫ ПРИСОЕДИНЕНИЯ

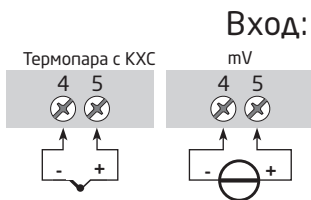

ВЫХОД:

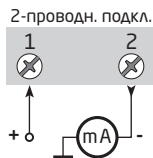

ПРИНЦИПИАЛЬНАЯ СХЕМА

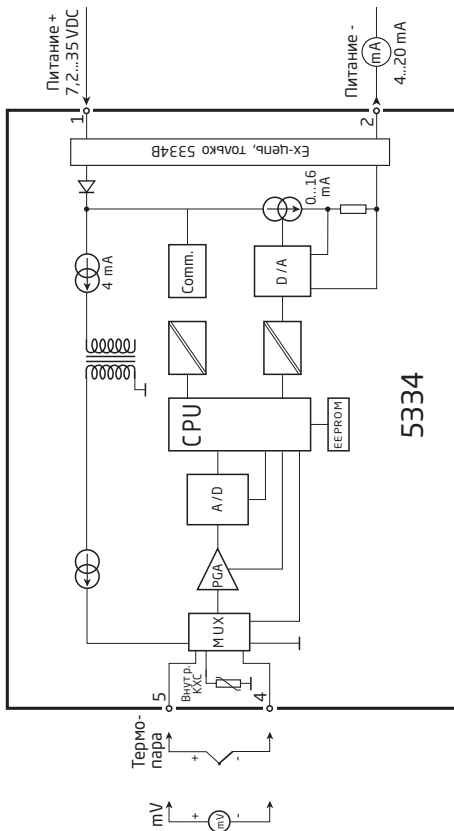

ПРОГРАММИРОВАНИЕ

- Loop Link представляет собой питаемый от батареи интерфейс обмена данными, необходимый для программирования PRetop 5334.
- О процедуре программирования см. илл. ниже и справочно-информационную функцию в ПО PReset.
- Loop Link нельзя использовать для связи с модулями, установленными во взрывоопасной (Ex) зоне.

Наименование при заказе: Loop Link

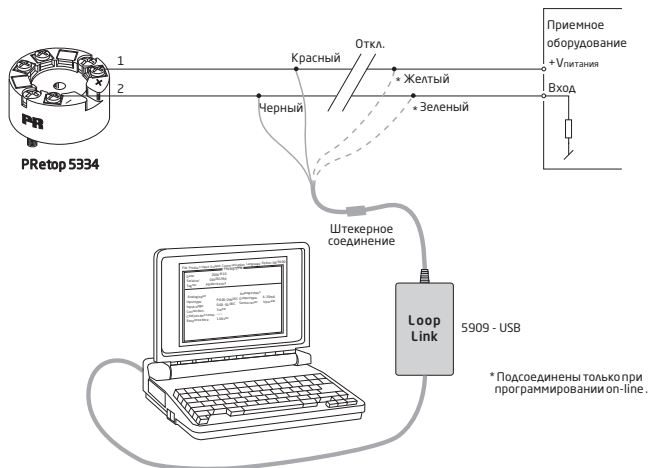

Установочные размеры

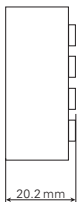
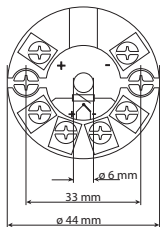

Монтаж кабеля датчика

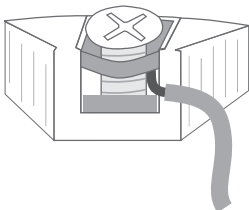

Провод монтируют между пластинами

ПРИЛОЖЕНИЕ

ATEX Installation Drawing - 5334A

ATEX Installation Drawing - 5334B

IECEX installation drawing - 5334A

IECEX installation drawing - 5334B

INMETRO Instruções de Segurança - 5334A

INMETRO Instruções de Segurança - 5334B

ATEX Installation drawing

For safe installation of 5331A3B or 5334A3B the following must be observed. The module shall only be installed by qualified personnel who are familiar with the national and international laws, directives and standards that apply to this area.

Year of manufacture can be taken from the first two digits in the serial number.

ATEX Certificate KEMA 10ATEX 0002 X

Marking



II 3 G Ex nA [ic] IIC T4 ... T6 Gc
II 3 G Ex ic IIC T4...T6 Gc
II 3 D Ex ic IIIC Dc

Standards EN 60079-0 : 2012, EN 60079-11 : 2012, EN 60079-15 : 2010

T4: $-40 \leq T_a \leq 85^\circ\text{C}$
T6: $-40 \leq T_a \leq 60^\circ\text{C}$

Terminal: 3,4,5,6
Ex nA [ic]

Uo: 9.6 V
Io: 25 mA
Po: 60 mW
Lo: 33 mH
Co: 2.4 μF

Terminal: 1,2
Ex nA

Umax \leq 35 VDC

Terminal: 1,2
Ex ic

Ui = 35 VDC
Ii = 110 mA
Li = 10 μH
Ci = 1.0 nF

Special conditions for safe use.

For type of protection Ex nA, the transmitter shall be mounted in a metal enclosure providing a degree of protection of at least IP54 according to EN60529.

For use in the presence of combustible dusts the transmitter shall be mounted in an enclosure providing a degree of protection of at least IP6X in accordance with EN60529, the surface temperature of the outer enclosure is 20 K above the ambient temperature.

For an ambient temperature $\geq 60^\circ\text{C}$, heat resistant cables shall be used with a rating of at least 20 K above the ambient temperature.

ATEX Installation drawing



For safe installation of 5331D or 5334B the following must be observed. The module shall only be installed by qualified personnel who are familiar with the national and international laws, directives and standards that apply to this area.

Year of manufacture can be taken from the first two digits in the serial number.

ATEX Certificate KEMA 06ATEX 0062 X

Marking  II 1 G Ex ia IIC T4...T6 Ga
II 1 D Ex ia IIIC Da
II 1 M Ex ia I Ma

Standards EN 60079-0 : 2012, EN 60079-11 : 2012, EN 60079-26 : 2007,
EN 60079-15 :2010

Hazardous area

Zone 0, 1, 2, 20, 21, 22

T4: $-40 \leq T_a \leq 85^\circ\text{C}$

T6: $-40 \leq T_a \leq 60^\circ\text{C}$

Terminal: 3,4,5,6

Uo: 9.6 VDC

Io: 25 mA

Po: 60 mW

Lo: 33 mH

Co: 2.4 μ F

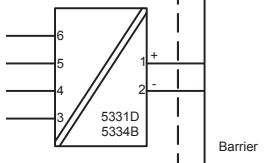

Terminal: 1,2

Ui: 30 VDC

Ii: 120 mA

Pi: 0.84 W

Li: 10 μ H

Ci: 1.0 nF

Installation notes.

The sensor circuit is not infallibly galvanic isolated from the input circuit. However, the galvanic isolation between the circuits is capable of withstanding a test voltage of 500Vac during 1 minute.

In a potentially explosive gas atmosphere, the transmitter shall be mounted in an enclosure in order to provide a degree of protection of at least IP20 according to EN60529.

If the transmitter is installed in an explosive atmosphere requiring the use of equipment of category 1 G, 1 M or 2 M, and if the enclosure is made of aluminum, it must be installed such, that ignition sources due to impact and friction sparks are excluded.

if the enclosure is made of non-metallic materials, electrostatic charging shall be avoided.

For installation in a potentially explosive dust atmosphere, the following instructions apply:

The transmitter shall be mounted in a metal enclosure form B according to DIN43729 that is providing a degree of protection of at least IP6X according to EN60529, that is suitable for the application and correctly installed.

Cable entries and blanking elements shall be used that are suitable for the application and correctly installed.

For an ambient temperature $\geq 60^{\circ}\text{C}$, heat resistant cables shall be used with a rating of at least 20 K above the ambient temperature.

The surface temperature of the enclosure is equal to the ambient temperature plus 20 K, for a dust layer with a thickness up to 5 mm

IECEx Installation drawing



For safe installation of 5331A or 5334A the following must be observed. The module shall only be installed by qualified personnel who are familiar with the national and international laws, directives and standards that apply to this area.

Year of manufacture can be taken from the first two digits in the serial number.

Certificate	IECEx DEK 13.0035X		
Marking	Ex nA [ic] IIC T4..T6 Gc Ex ic IIC T4..T6 Gc Ex ic IIIC Dc		
Standards	IEC 60079-0 : 2011, IEC 60079-11 : 2011, IEC 60079-15 : 2010		

T4: $-40 \leq T_a \leq 85^\circ\text{C}$
T6: $-40 \leq T_a \leq 60^\circ\text{C}$

Terminal: 3,4,5,6

Uo: 9.6 V
Io: 25 mA
Po: 60 mW
Lo: 33 mH
Co: 2.4 μF

Terminal: 1,2

Ex nA
Umax = 35 VDC

Terminal: 1,2

Ex ic
Ui = 35 VDC
Ii = 110 mA
Li = 10 μH
Ci = 1.0 nF

Installation note:

For installation in a potentially explosive gas atmosphere, the following instructions apply:

For nA installation the transmitter must be installed in an metal enclosure, e.g. a form B enclosure providing a degree of protection of at least IP54 according to IEC60529 or in an enclosure with type of protection Ex n or Ex e.

For ic installation the transmitter must be installed in enclosure providing a degree of protection of at least IP20 according to IEC60529 and that is suitable for the application.

Cable entry devices and blanking elements shall fulfill the same requirements

For an ambient temperature $\geq 60^\circ\text{C}$, heat resistant cables shall be used with a rating of at least 20 K above the ambient temperature.

For installation in a potentially explosive dust atmosphere, the following instructions apply:

The surface temperature of the enclosure is equal to the ambient temperature plus 20 K, for a dust layer with a thickness up to 5 mm.

The transmitter must be mounted in a enclosure according to DIN 43729 that provides a degree of protection of at least IP6X according to IEC60529, and that is suitable for the application. Cable entry devices and blanking elements shall fulfill the same requirements.

IECEx Installation drawing



For safe installation of 5331D or 5334B the following must be observed. The module shall only be installed by qualified personnel who are familiar with the national and international laws, directives and standards that apply to this area.

Year of manufacture can be taken from the first two digits in the serial number.

Certificate	IECEx DEK 13.0035X
Marking	Ex ia IIC T4...T6 Ga Ex ia IIC Da Ex ia I Ma
Standards	IEC 60079-0 : 2011, IEC 60079-11 : 2011, IEC 60079-26:2006

Hazardous area
Zone 0, 1, 2, 20, 21, 22, M1

T4: $-40 \leq T_a \leq 85^\circ\text{C}$

T5: $-40 \leq T_a \leq 60^\circ\text{C}$

T6: $-40 \leq T_a \leq 45^\circ\text{C}$

Terminal: 3,4,5,6

Uo: 9.6 VDC

Io: 25 mA

Po: 60 mW

Lo: 33 mH

Co: 2.4 μF

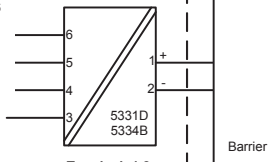

Terminal: 1,2

Ui: 30 VDC

Ii: 120 mA

Pi: 0.84 W

Li: 10 μH

Ci: 1.0 nF

Installation notes.

The sensor circuit is not infallibly galvanic isolated from the input circuit. However, the galvanic isolation between the circuits is capable of withstanding a test voltage of 500Vac during 1 minute.

In a potentially explosive gas atmosphere, the transmitter shall be mounted in a metal form B enclosure in order to provide a degree of protection of at least IP20 according to IEC60529. If however the environment requires a higher degree of protection, this shall be taken into account.

If the transmitter is installed in an explosive atmosphere requiring the use of equipment protection level Ga, Ma and Mb, and if the enclosure is made of aluminum, it must be installed such, that ignition sources due to impact and friction sparks are excluded.

For installation in a potentially explosive dust atmosphere, the following instructions apply:

For explosive dust atmospheres, the surface temperature of the outer enclosure is 20 K above the ambient temperature.

The transmitter shall be mounted in a metal enclosure form B according to DIN43729 that is providing a degree of protection of at least IP6X according to IEC60529, that is suitable for the application and correctly installed.

Cable entries and blanking elements shall be used that are suitable for the application and correctly installed.

For an ambient temperature $\geq 60^{\circ}\text{C}$, heat resistant cables shall be used with a rating of at least 20 K above the ambient temperature.

Desenho de Instalação INMETRO



Para instalação segura do 5331A ou 5334A o seguinte deve ser observado. O modo deve apenas ser instalado por pessoas qualificadas que são familiarizadas com as leis nacionais e internacionais, diretrizes e padrões que se aplicam a esta área.

Ano de fabricação pode ser pego dos dois primeiros dígitos do número de série.

Certificado	DEKRA 13.0001 X
Indicação	Ex nA [ic] IIC T4..T6 Gc Ex ic IIC T4..T6 Gc Ex ic IIIC Dc

Padrões ABNT NBR IEC 60079-0 : 2008, ABNT NBR IEC 60079-11 : 2009,
IEC 60079-15 : 2010, ABNT NBR IEC 60079-26 : 2008

T4: $-40 \leq T_a \leq 85^\circ\text{C}$ T6: $-40 \leq T_a \leq 60^\circ\text{C}$	Terminal: 3,4,5,6 Uo: 9,6 V Io: 25 mA Po: 60 mW Lo: 33 mH Co: 2,4 μF	Terminal: 1,2 Ex nA Umax =35 VDC	Terminal: 1,2 Ex ic Ui = 35 VDC Ii = 110 mA Li = 10 μH Ci = 1,0 nF
--	---	---	---

Notas para instalação

Para a instalação em uma atmosfera de gás potencialmente explosivo, se aplicam as instruções a seguir:

Para a instalação nA o transmissor deve ser instalado em um gabinete de metal, por exemplo, gabinete em forma B que forneça um grau de proteção de pelo menos IP54 de acordo com IEC60529 ou em um caixa com tipo de proteção Ex n ou Ex e.

Para a instalação IC o transmissor deve ser instalado em um invólucro proporcionando um grau de proteção de IP20, pelo menos, de acordo com a norma IEC60529 que é adequado para a aplicação.

Dispositivos de entrada de cabos e elementos de supressão devem cumprir os mesmos requisitos.

Para uma temperatura ambiente $\geq 60^\circ\text{C}$, os cabos resistentes ao calor precisam ser utilizados com uma classificação de pelo menos 20 K acima da temperatura ambiente.

Para a instalação em uma atmosfera de poeira potencialmente explosiva, se aplicam as instruções a seguir:

A temperatura da superfície do invólucro é igual à temperatura ambiente mais 20 K, para uma camada de pó, com uma espessura superior a 5 mm.

O transmissor deve ser montado em um invólucro de acordo com a norma DIN 43729, que proporciona um grau de proteção de, pelo menos, IP6X de acordo com a norma IEC60529, e que seja apropriado para a aplicação.

Dispositivos de entrada de cabos e elementos de supressão devem cumprir as mesmas exigências.

Desenho de Instalação INMETRO



Para instalação segura do 5331D ou 5334B o seguinte deve ser observado. O modo deve apenas ser instalado por pessoas qualificadas que são familiarizadas com as leis nacionais e internacionais, diretrizes e padrões que se aplicam a esta área.
Ano de fabricação pode ser pego dos dois primeiros dígitos do número de série.

CertificadoDEKRA 13.0001 X

Indicação Ex ia IIC T6...T4 Ga
Ex ia IIIC Da

Padrões ABNT NBR IEC 60079-0 : 2008 ABNT NBR IEC 60079-11 : 2009 IEC 60079-15 : 2010
ABNT NBR IEC 60079-26 : 2008

Áreas Perigosas

Zona 0, 1, 2, 20, 21, 22,

T4: $-40 \leq T_a \leq 85^\circ\text{C}$

T5: $-40 \leq T_a \leq 60^\circ\text{C}$

T6: $-40 \leq T_a \leq 45^\circ\text{C}$

Terminal: 3,4,5,6

Uo: 9,6 VDC

Io: 25 mA

Po: 60 mW

Lo: 33 mH

Co: 2,4 μ F

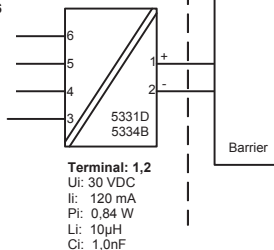

Sem áreas perigosas

Terminal: 1,2

Ui: 30 VDC

Ii: 120 mA

Pi: 0,84 W

Li: 10 μ H

Ci: 1,0nF

Notas de instalação

O circuito do sensor não é isolado galvanicamente infalível do circuito de entrada. Contudo, a isolação galvânica entre os circuitos é capaz de resistir a um teste de tensão de 500Vac durante 1 minuto.

Em uma atmosfera de gás potencialmente explosiva, o transmissor deve ser montado em um enclosure a fim de garantir um grau de proteção de no mínimo IP20 de acordo com EN60529. Se contudo o ambiente requer um nível de proteção maior, isso deve ser levado em conta

Se o transmissor é instalado em uma atmosfera explosiva exigindo o uso de equipamento de categoria Ga e se o enclosure é feito de alumínio, ele deve ser instalado de modo que, mesmo em caso de avaria rara, fontes de ignição devido a impacto e fricção, faíscas são eliminadas; se o enclosure é feito de materiais não metálicos, cargas eletroestáticas devem ser evitadas.

Para instalação em atmosfera de poeira potencialmente explosiva, as instruções a seguir:

O transmissor deve ser montado em enclosure de metal forma B de acordo com DIN43729 que está fornecendo um grau de proteção de pelo menos IP6X de acordo com EN60529. Isso é adequado para aplicação e corretamente instalado.

As entradas dos cabos e os elementos de obturação que podem ser utilizados são adequados para a aplicação e corretamente instalados.

Para temperatura ambiente $\geq 60^{\circ}\text{C}$, fios de resistência ao calor devem ser usados com uma faixa de pelo menos 20K acima da temperatura ambiente.

A temperatura da superfície do enclosure é igual à temperatura ambiente mais de 20 K, por uma camada de pó, com uma espessura até 5 mm.



Индикаторы Программируемые дисплеи с большим выбором вводов и выводов для индикации температуры, объема, веса и т. д. Обеспечивают линейаризацию и масштабирование сигналов, имеют ряд измерительных функций, программируемых при помощи ПО PReset.



Ex-барьеры Интерфейсы для аналоговых и цифровых сигналов и сигналов HART® между датчиками / преобразователями I/P / сигналами частоты и СУ в опасных зонах Ex 0, 1 и 2, ряд модулей - в опасных зонах 20, 21 и 22.



Развязка Устройства гальванической развязки аналоговых и цифровых сигналов, а также сигналов в протоколе HART®. Обширная программа модулей с питанием от токовой петли или универсальным, для линейаризации, инвертирования и масштабирования выходных сигналов.



Температура Широкий выбор температурных преобразователей для монтажа в корпусе датчика стандарта DIN типа В и для установки на DIN-рейке, с обменом аналоговых и цифровых данных по шине. Предлагаются как под конкретные применения, так и универсальные.



Универсальность Программируемые с ПК или с панели модули с универсальным рядом вводов, выводов и питания. Модули этого ряда имеют функции высокого порядка, напр. калибровка процесса, линейаризация и самодиагностика.



  www.preelectronics.fr
 sales@preelectronics.fr



  www.preelectronics.de
 sales@preelectronics.de

  www.preelectronics.es
 sales@preelectronics.es

  www.preelectronics.it
 sales@preelectronics.it

  www.preelectronics.se
 sales@preelectronics.se

  www.preelectronics.com
 sales@preelectronics.com

  www.preelectronics.com
 sales@preelectronics.com

  www.preelectronics.cn
 sales@preelectronics.cn

Головной офис

Denmark - Дания
PR electronics A/S
Lerbakken 10
DK-8410 Rønde

www.preelectronics.com
sales@preelectronics.dk
тел. +45 86 37 26 77
факс +45 86 37 30 85



QUALITY SYSTEM AND ENVIRONMENTAL MANAGEMENT SYSTEM
DS/EN ISO 9001
DS/EN ISO 14001

